

DESCRIPTION

This is a high speed InGaAs detector optimized for fiber optic applications requiring high Responsivity and a fast response time.

FEATURES

- High Responsivity
- High Electrical Bandwidth/Fast response time
- High Reliability/Hermetic Package
- 75 μm Diameter Active Area

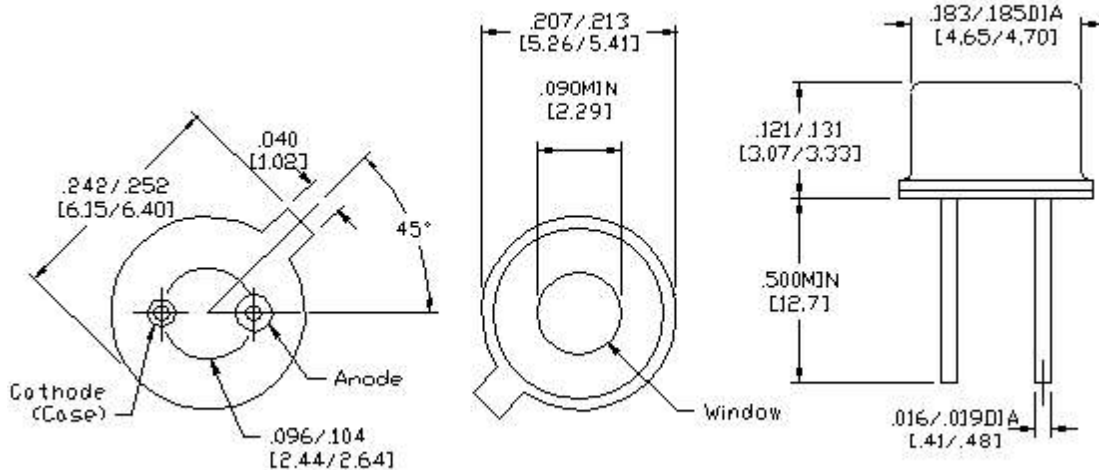

ABSOLUTE MAXIMUM RATINGS

- Storage temperature..... -55°C to +125°C
- Case operating temperature..... -40°C to +85°C
- Lead solder temperature..... 260°C, 10 seconds
- Reverse Breakdown Voltage..... 30 Volts
- Reverse Current..... 250 μA
- Forward Current..... 5 mA

OUTLINE DIMENSIONS

Tolerances are +/-0.005 inches, except as noted
The case is electrically isolated from the pins.

PARAMETER	TEST CONDITION	SYMBOL	MIN	TYP	MAX	UNIT
Dark Current	Vr = 5 Volts, H = 0 mW	Id		1	5	nA
Capacitance	Vr = 0 V, f = 1 MHz	C		0.75	2.0	pF
Responsivity	Vr = 5 Volts λ = 1.31 μm	R _c	.8	0.9		A/W
Responsivity	Vr = 5 Volts λ = 1.55 μm	R _c	.9	1.05		A/W
Spectral Response		λ	800		1700	nm
Response Time	10%-90%, Vr = 5 Volts	t _r t _f		0.1 0.1		nsec nsec

ELECTRO-OPTICAL CHARACTERISTICS (Case T = 25°C)